

# ***SPARKLE***

## 61" Wall Panel



# Installation Guidelines

**NunoErin**<sup>®</sup>

CUSTOMER SERVICE / ASSISTANCE

+1 601.994.0023 [support@nunoerin.com](mailto:support@nunoerin.com)

[info@nunoerin.com](mailto:info@nunoerin.com) [www.nunoerin.com](http://www.nunoerin.com)

## Product Specifications

**MODEL:** SPWP-61H  
**DIMENSIONS:** 61.5" x 28.5" x 3.75"

### MATERIAL SPECIFICATIONS:

**Display:** Full Spectrum LED Lights  
**Touch:** Capacitive Touch Sensors  
**Top Surface:** Translucent white solid surface  
**Frame:** Opaque white solid surface sides  
**Mounting:** Heavy duty Z-Clip mounting brackets  
**Temperature:** Operation: 0~50 C, Storage: -20 / 60 C  
**Weight (Panel only):** 144 lbs.

### ELECTRICAL/POWER:

**Power Cord:** USA 3-pin plug NEMA 5-15P  
 Right Angle to IEC C13 Right Angle,  
 16 AWG, Length 2 feet  
**Power supply / AC Input:**  
 Voltage Range: 90 ~ 132 VAC  
 (Universal AC Input / Full Range)  
 AC Current: 1.2A / 115 VAC  
 Frequency Range: 47 ~ 63 Hz



LPS IP67

## PARTS INCLUDED

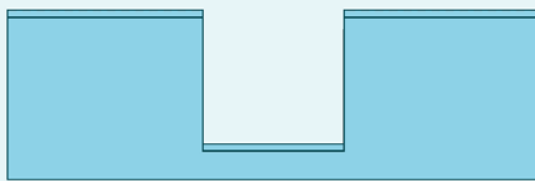

**1**  
Wall Mount Z-Clip

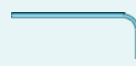

**1**  
5/16" Hex Key

## PARTS and TOOLS NEEDED



**1**  
Philips Head Screwdriver



**1**  
Power Drill

### NOTE:

Wall brackets must be mounted to studs or blocking in the wall, using the appropriate size and type of hardware for the wall construction, and must be capable of supporting the panel weight of approximately 280 pounds.

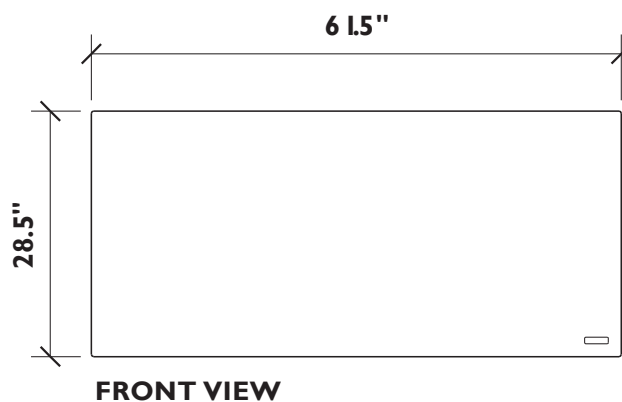

FRONT VIEW

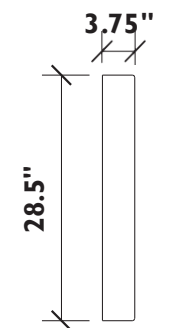

SIDE VIEW



BOTTOM VIEW

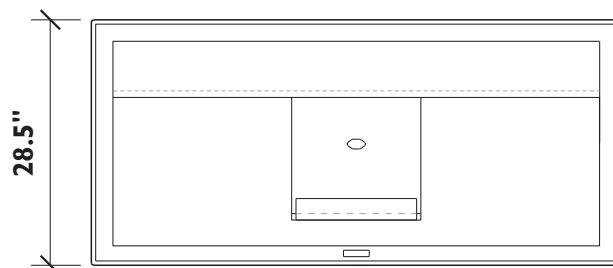

BACK VIEW

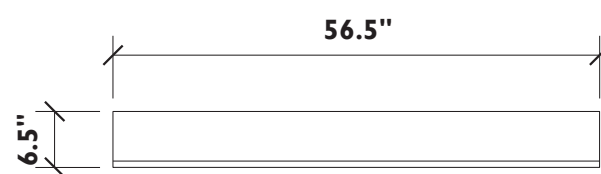

PANEL Z-CLIP



SIDE VIEW

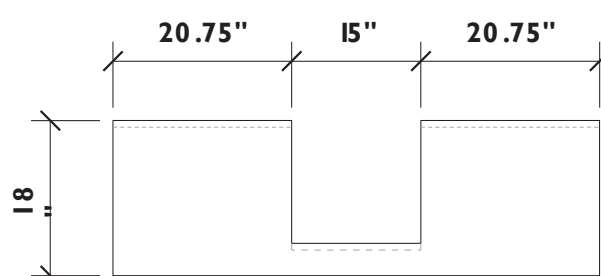

WALL Z-CLIP



SIDE VIEW

- 1 Install recessed duplex receptacle on target wall using the dimensions shown.

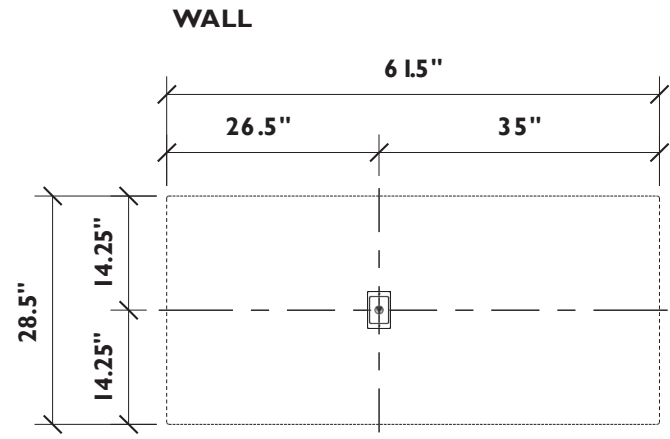

- 2 Install Z-Clips provided for wall mounting.

Use appropriate hardware for wall type.

**NOTE:** Z-clips must be secured to studs or blocking to ensure that the weight of the panel is fully supported.

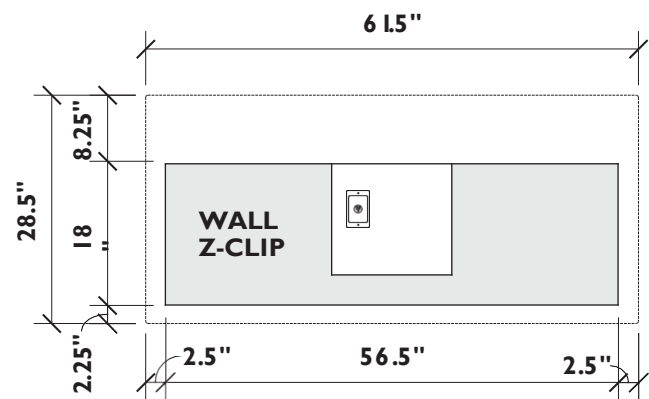

- 3 With panel held close to wall, attach power cord.

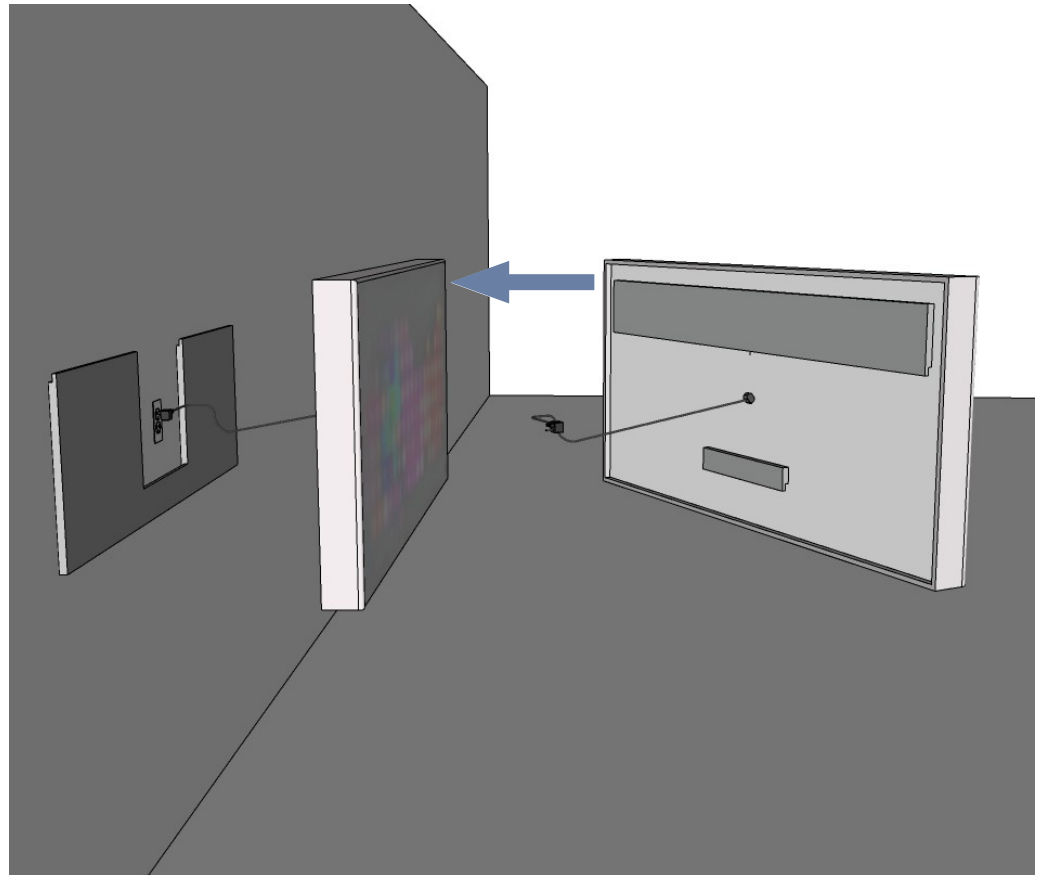

- 4 Align panel over the Wall Mount Z-Clips.

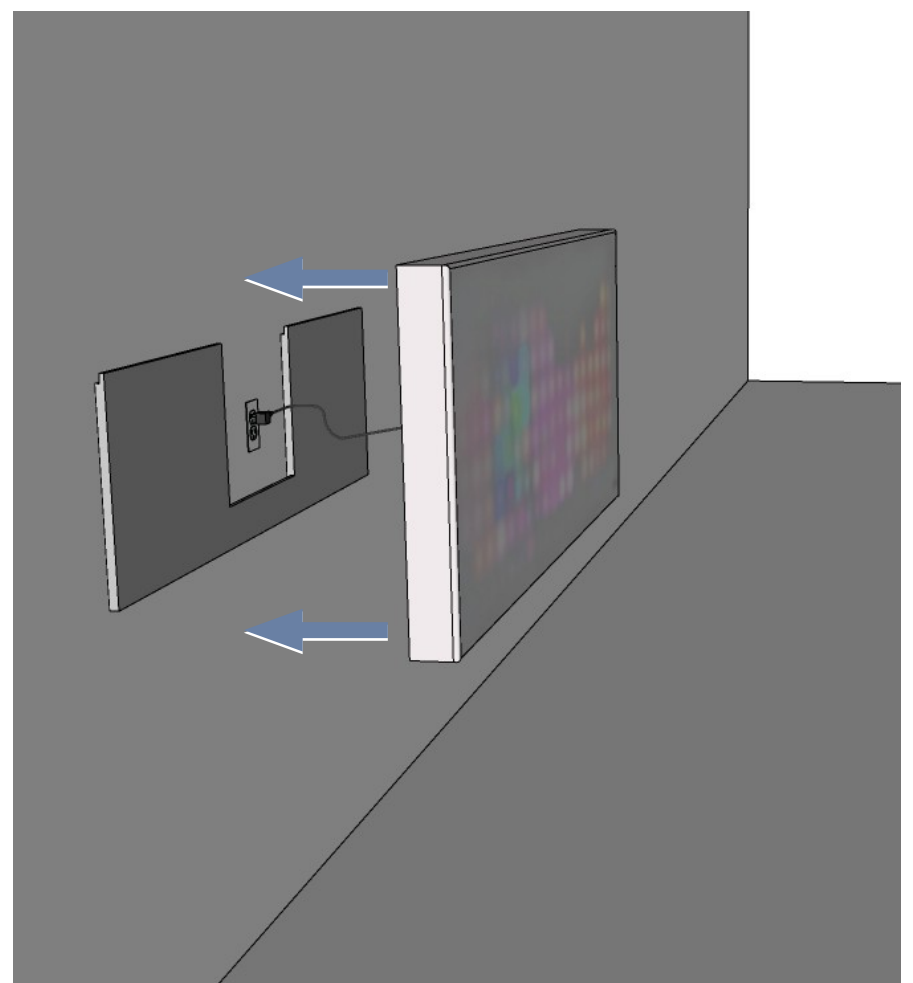
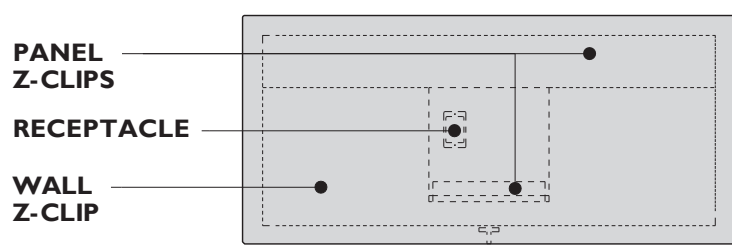

- 5 Move panel firmly down to securely engage with the Wall Mount Z-Clips

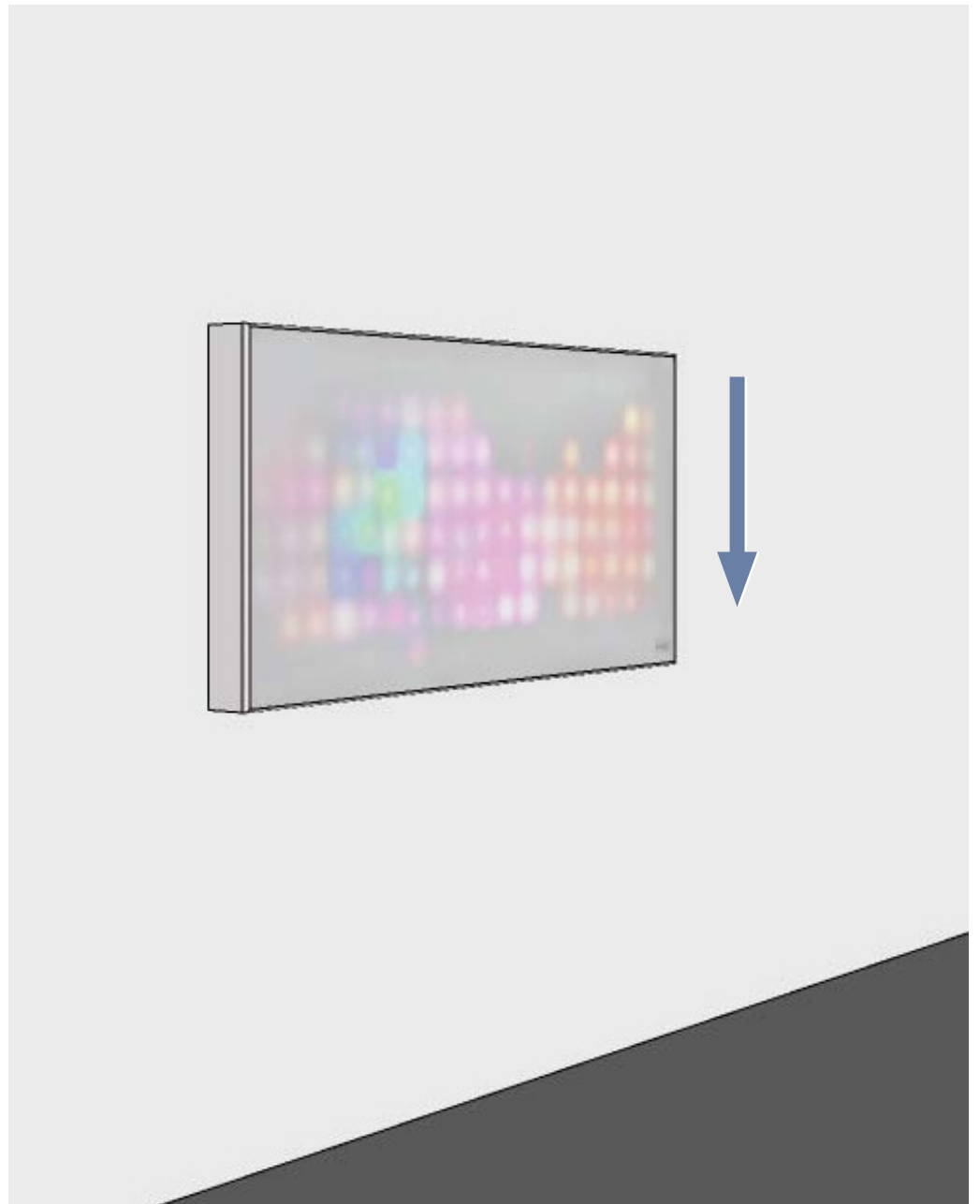

- 6 **WARNING:**  
Do Not Skip This Step

Remove plastic cap on bottom of panel to access security latch hex nut.

Use 5/16" hex key provided to secure and lock panel into place.

After locking security latch, place plastic cap over hole to prevent access.

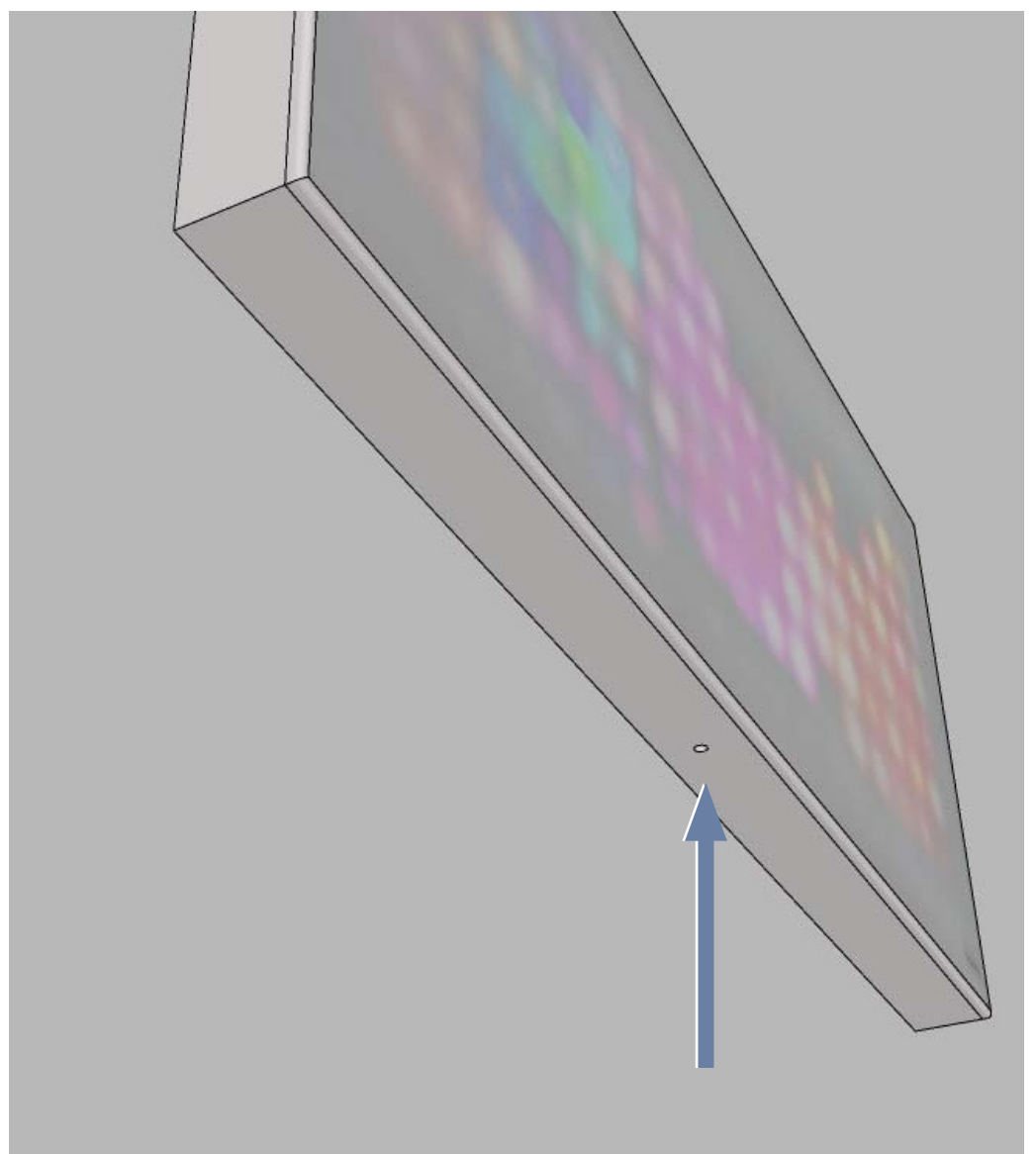

- 7 When the Sparkle Panel is first powered on, it will flash a pattern for approximately 10 seconds, while calibrating to the ambient conditions, then the interactive programs will begin to play.





# 61" Wall Panel



## CLEANING AND MAINTENANCE

### Top and Sides

Spray the top and side surfaces with a multi surface cleaner and wipe using a soft cloth. Recommended cleaners include Fantastik household cleaner and Formula 409 household cleaner.

### Disinfecting

Sani-Cloth® AF3 Germicidal Disposable Wipes, Steris Coverage Plus® and Clorox Healthcare® Hydrogen Peroxide Cleaner Disinfectant Wipes are recommended.

**DO NOT USE STRONG ACIDIC OR SOLVENT BASED CLEANERS, SUCH AS METHYLCHLORIDE OR ACETONE.**

### Scratches

Superficial scratches on the top surface only can be removed by rubbing a wet #7448 ScotchBrite pad in a circular motion until the scratches disappear, followed by spraying with a multi-surface cleaner and wiping dry with a soft cloth. Never use abrasive cleaners on the laminate sides, which will dull or damage the finish.

## ELECTRICAL

This product is for use on a nominal Universal Power 110 - 220 VAC circuit and must be plugged into an appropriate outlet that is properly installed and grounded in accordance with all local codes and ordinances.

**NOTE: IMPROPER CONNECTION OF EQUIPMENT GROUNDING CONDUCTOR CAN RESULT IN A RISK OF ELECTRIC SHOCK.** Check with a qualified electrician or serviceman if you are in doubt as to whether the product is properly grounded. Do not modify the plug provided with the product, or if it will not fit the outlet. Have a proper outlet installed by a qualified electrician.

**INSTALLATION OF NUNOERIN PRODUCTS.** Installation of all NunoErin product is solely the responsibility of the builder, contractor, interior designer and decor vendor, or the Customer. NunoErin has no control over the installer or the installation process and will not be responsible for any installations that are not done in a good, workmanlike manner, that do not follow NunoErin installation recommendations noted in the Product Literature or that fail to conform to electrical codes. NunoErin assumes no responsibility for such compliance. Consult your local building code officials for specific requirements.

**Note:** No NunoErin representative, dealer or salesperson is authorized to assist in the measurement of installation of NunoErin Products in the field. Customers are advised to obtain the proper measurement, specifications and sizes only from their builder, designer or engineer. Accordingly, any assistance provided in the field by a NunoErin representative should not be relied upon and will not be binding upon NunoErin in any form or fashion. NunoErin shall not be liable in any form of measures from incorrect measurements or specifications made in the field, irrespective of whether a NunoErin representative was involved in the process.

**NunoErin**<sup>®</sup>

533 Commerce Street  
Jackson, MS 39201 USA

O: 01.601.944.0023 **Customer Service:** [support@nunoerin.com](mailto:support@nunoerin.com)

NunoErin. ©2020